

*Exploring Coffee Secrets*



**C12**

Fully automatic coffee machine user manual

# Contents

<b>1</b>	<b>Introductions.</b>	<b>4</b>
1.1	Greetings.	4
1.2	About the manual.	4
1.3	Machine description.	4
<b>2</b>	<b>Machine description.</b>	<b>5</b>
2.1	Machine introductions.	5
2.2	Technical parameters.	6
2.2.1	Output capacity.	6
2.2.2	Specification parameters.	6
2.3	Accessories	7
2.3.1	Accessories supplied.	7
2.3.2	Accessories and device options.	7
<b>3</b>	<b>Electrical schematic.</b>	<b>8</b>
<b>4</b>	<b>Security matters.</b>	<b>9</b>
4.1	Application.	9
4.2	Safety warning.	9
4.2.1	User risks.	9
4.2.2	Hazards to Machine.	11
4.2.3	Dangers of cleaning agents.	12
4.2.4	Health rules.	13
<b>5</b>	<b>Installation and testing.</b>	<b>15</b>
5.1	Placement Requirements.	15

There is difference between picture and products, because of the upgrading of products. Please refer to the actual products.

5. 1. 1	Location	15
5. 1. 2	Climate conditions	15
5. 1. 3	Power conditions	16
5. 1. 4	Water conditions	16
5. 2	First run	17
5. 3	Machine On/Off	18
<b>6</b>	<b>Beverage making</b>	<b>20</b>
6. 1	Coffee	20
6. 2	Milk Beverage	21
6. 3	Hot water	23
<b>7</b>	<b>Cleaning and maintenance</b>	<b>24</b>
7. 1	Daily cleaning	24
7. 1. 1	Brewer rinse	24
7. 1. 2	Milk rinse	25
7. 1. 3	Milk frother disassembly and cleaning	26
7. 2	Regular maintenance	28
7. 2. 1	Brewer deep clean	28
7. 2. 2	Milk deep clean	29
7. 2. 3	Descaling	30
7. 2. 4	Grinding adjustment	31
<b>8</b>	<b>Precautions for daily use and maintenance</b>	<b>32</b>
<b>9</b>	<b>Trouble shooting and Handling</b>	<b>33</b>
<b>10</b>	<b>Liability and Warranty</b>	<b>36</b>

10. 1	User responsibility	36
10. 2	Warranty and Liability	36

# 1 Introductions

## 1.1 Greetings

- This coffee machine is the latest generation of fully automatic coffee machines we have developed. Its design fully reflects our core technology.
- The manual introduces the coffee machine and use rules. Be sure to follow our Terms of Use and Precautions. For more information, please contact our customer service.
- The performance of coffee machine depends on proper maintenance and use. Please read the instruction manual carefully before using the coffee machine for the first time. Happy using!

## 1.2 About manual

- This manual is default part, please always keep it in the place where the product is used and keep it clearly readable.
- Due to the further development of technology, we reserve the right to revise this manual, and unauthorized photocopying and modification are prohibited.
- This manual applies to the model: C12

## 1.3 Machine description

- For use only to make coffee, hot water and milk, do not use for other purposes.
- Depending on the machine configuration, the following products can be made: coffee, milk coffee and milk products.
- The housing is made of high-grade plastic. This machine and all auxiliary equipment are designed to comply with the following operator obligations:
  - HACCP Sanitation Guidelines;

- Accident prevention regulations for electrical safety in the commercial sector;
- The operation of this machine is performed via a touch-sensitive screen (touch screen).

# 2 Machine description

## 2.1 Machine introductions

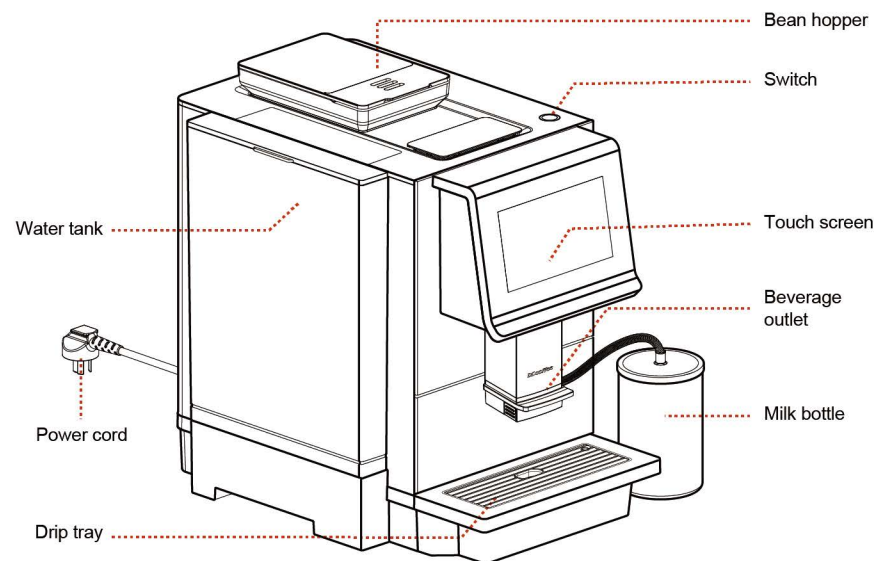

## 2.2 Technical Parameters

### 2.2.1 Output capacity

Cups per hour based on DIN18873-2:

Daily output	30 Cups
Cups per hour	
Espresso (Volume50ml)	70 Cups
Americano (Volume240ml)	50 Cups
Cappuccino (Volume180ml)	50 Cups
Hot water output per hour	15L
Water tank capacity	4L
Coffee bean hopper capacity	Around 250g
Grounds container capacity	About 15 pcs (10g/piece)

### 2.2.2 Specification parameters

Rated voltage	220-240V~
Rated Frequency	50Hz
Rated power	1450W
Machine W*D*H	31*47*45cm
Net weight	15kg
Gross weight	17kg



## 2.3 Accessories

### 2.3.1 Accessories supplied

This model supply the spare parts as follows:

Name	Picture	Qty
Machine		x1
Quick start guide		x1
Milk bottle		x1

### 2.3.1 Accessories and device options

Name	Picture	Description
Espresso machine cleaner		For coffee machine brewing system deep clean, eliminate the coffee grease inside the brewer, non-toxic and tasteless
Milk system coffee machine cleaner		For deep cleaning of milk bottle and milk system, eliminate the residue of milk scale inside the milk froth, non-toxic and tasteless
Descaling powder		For descaling, remove limescale from the coffee machine container to ensure the pure taste of coffee

### 3 Electrical schematic

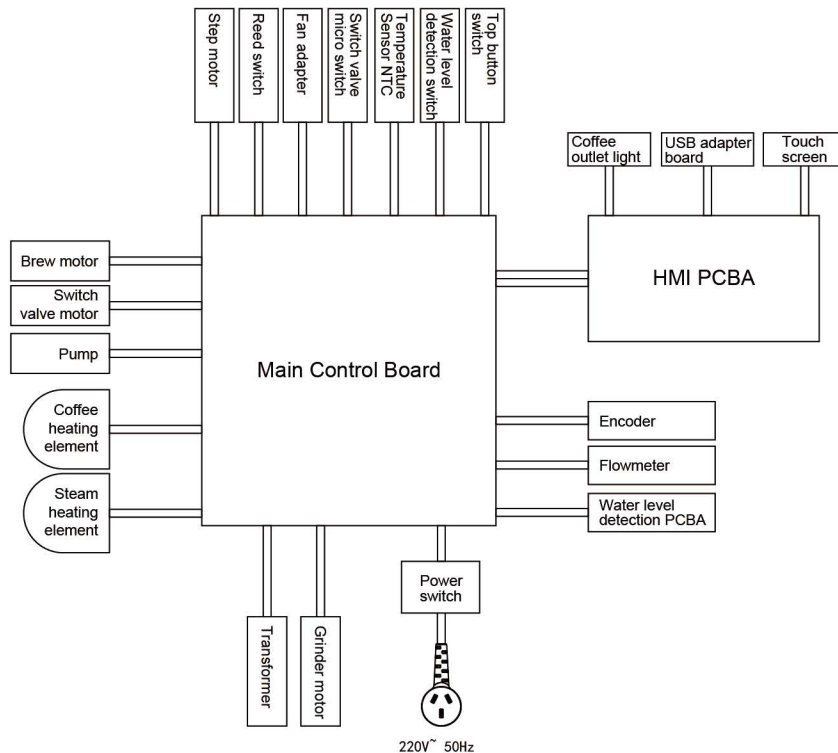

### 4 Security matters

Optimum Safety One of Dr. Coffee's most important product features. The effectiveness of the safety device can only be guaranteed if the instructions for use in the following chapters are followed.

#### 4.1 Application

This machine and all auxiliary equipment are suitable for use in the following working states:

- Under supervision, self-service operation runs (standby mode);
- Use a solid water connection;
- Filtered municipal water;
- Fixed location in a dry, closed room.

This machine and all auxiliary equipment must not be used in the following ways:

- In areas with high air humidity (e.g. cloud steaming areas) or outdoor areas;
- On transport or in movable space (consult manufacturer).

#### 4.2 Safety warning

##### 4.2.1 User risks

- ⚠ **Attention:** Incorrect use of the coffee machine can cause minor injury. Be sure to observe the following points:
  - Please read the instructions carefully before use;
  - Do not use if coffee machine is not functioning properly or is damaged;
  - It is strictly forbidden to modify the built-in safety device;
  - Do not touch high temperature machine parts;
  - Children over 8 years of age and persons with physical, sensory or intellectual impairments or lack of experience and cognition must learn how to operate the machine safely and understand the dangers that result before using the machine under continuous supervision;

- Please supervise children, avoid children playing with the machine, cleaning and user maintenance should not be carried out by children;
- Install the coffee machine in a place where it can be looked after and maintained at any time;



**Warning electric shock: Improper use of electrical equipment can result in electric shock. Please observe the following points:**

- Work on electrical equipment may only be carried out by electrical professionals;
- The machine must be connected to a circuit protected by fuses (we recommend laying the wiring through a leakage protector);
- Please abide by the relevant low voltage directives and national or local safety regulations;
- When connecting, it must be grounded in strict accordance with regulations and prevent electric shock;
- The voltage must be consistent with the description on the equipment nameplate;
- Do not touch live parts.
- Always switch off the main switch and disconnect the device from the mains before carrying out maintenance work.
- The power cord should only be replaced by a professional service technician.



**Scalding Hazard: Risk of scalding in areas where beverages, hot water and steam are made. Do not put your hands under the spout during preparation or cleaning.**



**Scalding Hazard: High temperature may be present at the spout and the brewing unit. Only allow access to handles pre-designed for production. Clean the brewing unit only after the machine has cooled down.**



**Crush Caution: There is a risk of crushing by touching any moving parts. Do not reach into the coffee bean hopper, powder hopper or opening of the brewing unit when the machine is switched on.**

#### 4. 2. 2 Hazards to Machines



**WARNING: Incorrect use of the coffee machine may result in damage or contamination of the machine.**

**Please observe the following points:**

- Damage to the coffee machine due to calcification if the carbonate hardness in the water exceeds 5°dKH;
- Please abide by the relevant low voltage directives and/or national and local safety rules and regulations; do not turn on the machine if water cannot be filled. Otherwise the boiler will not be refilled and the pump will run "dry";
- The coffee machine must be cleaned and then restarted after a prolonged shutdown (such as a corporate vacation);
- Protect the coffee machine from weather (frost, humidity, etc.)
- Troubleshooting can only be done by professional technicians;
- Please use original accessories from Dr. Ka company;
- For external visible damage or leakage, please contact customer service immediately for replacement or repair;
- Do not rinse the machine with water or use steam cleaners;
- Do not place the machine on surfaces that may be sprayed with water;
- Only coffee beans can be placed in the coffee bean bin, and only special instant powder can be placed in the powder bin;
- Freeze-dried coffee must not be used, as this will cause the brewing unit to stick;
- If the coffee machine and its accessories are transported at a temperature below 10°C, the coffee machine and its accessories must be left at room temperature for three hours after transport before they are plugged in and turned on. Failure to observe this may result in a risk of short circuits due to condensation or damage to electrical components;
- This product cannot be immersed in water for cleaning.

#### 4.2.3 Dangers of cleaning agents



**Use: Danger of poisoning by ingesting cleaning agents!**  
Please observe the following points:

- Cleaner storage should be kept away from children and unauthorized persons.
- Cleaning agents should not be ingested.
- Do not mix cleaners with other chemicals or acids.
- Never add cleaning agents to the drinking water tank.
- Cleaners and decalcifiers should only be used for their intended purpose (see label).
- Do not eat or drink while using the cleaner.
- Good ventilation and exhaust must be ensured when using cleaning agents.
- Wear protective gloves when working with cleaning agents.
- Wash hands thoroughly and immediately after using cleanser.



**Storage: Be sure to observe the following points:**

- Store out of the reach of children and unauthorized persons.
- When storing, pay attention to heat, light and moisture.
- Separated from acidic substances.
- Store only in original packaging.
- Keep cleaning agents separate.
- Do not store with food or drink.
- Applicable local laws and regulations on the storage of chemicals (cleaners).



**Exhaust Disposal: If the product is not available, the cleaning agent and its receptacle must be disposed of in accordance with local laws.**



**Emergency Advice: Ask the cleaning agent manufacturer (see detergent label) for the telephone number of the Emergency Advice (Toxicology Advice Center).**

#### 4.2.4 Health rules



**Water: Improper use of water can be a health hazard!**  
Please observe the following points:

- The water must be clean and free from contamination.
- Do not add corrosive water to the coffee machine.
- The carbonate hardness must not exceed 5~6 °dKH (German carbonate hardness) or 8.9~10.7 °fKH (French carbonate hardness).
- The total hardness value must always be higher than the carbonate hardness.
- The minimum carbonate hardness is 5 °dKH or 8.9 °fKH.
- The maximum chlorine content is 100 mg per liter.
- Ph value 6.5~7 (pH neutral).
- Machines with drinking water tanks (internal & external):
  - Fill the drinking water tank with clean water every day;
  - The drinking water tank must be thoroughly cleaned before adding water.



**Coffee: Incorrect use of coffee can be detrimental to your health!**  
Be sure to observe the following points:

- Check for damage before unpacking.
- Do not add more than one day's worth of coffee beans.
- Close the coffee bean compartment cover immediately after adding coffee beans.
- Coffee should be stored in a dry, cool and dark place.
- Coffee should be stored separately from detergents.
- The oldest product purchased should be used first ("early in, early out" principle).
- Please use it up within the warranty period.
- The package should be well sealed after opening to keep the product in the package fresh and prevent it from contamination.





Milk: It will harmful for the healthy with incorrect operation of milk!  
Please must observe the following points:

- Don't use raw milk.
- Only pasteurized and heat treated milk.
- Only homogenize milk.
- Only 3-5°C cold milk.
- Wear gloves during milk treatment.
- Only milk from original package.
- Filling milk into original package is not permitted.
- Thoroughly clean the milk bottle before filling.
- Check the package.
- The filling capacity of milk is no more than the daily usage.
- Close the cover of milk container and cooler after filling (Inside / Outside) .
- Keep the milk in dry, cold and enclosed room.(Highest temperature 7°C)
- Keep milk separate away from cleaners.
- The oldest purchased product should be used first ("early in, early out" principle).
- Please use it up within the warranty period.
- Seal package after opening it, to prevent it from pollution.

## 5 Installation and testing

### 5.1 Placement requirements

#### 5.1.1 location



The following conditions are suitable for placing the coffee machine. Failure to guarantee these conditions could damage the machine. Be sure to abide by the following conditions:

- The installation surface must be stable and flat, and will not deform under the condition of bearing the weight of the coffee machine;
- Do not place it near a hot surface or heat source;
- The coffee machine is located so that trained personnel can look after it at all times;
- The distance between the energy interface specified on the site installation drawing and the machine location shall not exceed 1m.
- Reserve some space for maintenance work and operation:
  - Leave enough space above to fill the coffee beans;
  - Keep a minimum distance of 5cm between the back of the device and the wall (air circulation);
  - Observe valid regulations on local cooking techniques.

#### 5.1.2 Climate conditions



The following climatic conditions are suitable for placing the coffee machine. Failure to guarantee these conditions may damage the machine. Be sure to abide by the following conditions:

- Ambient temperature maintained at +10°C to +40°C (50°F to 104°F)
- Relative air humidity up to 80 % rF;
- The coffee machine is designed for indoor use only. Do not use outdoors, protected from weather (rain, snow, frost)!
- If the ambient temperature of the coffee machine is below 0°C, the machine will not start.

### 5.1.3 Power conditions

- The electrical connection must be made in accordance with the relevant regulations of the country in which it is used. The voltage at the installation site must match the voltage given on the nameplate.

#### **Warning electric shock: Danger of electric shock!** Be sure to observe the following points:

- It must be protected by a fuse with the amperage value stated on the nameplate!
- All phases of the equipment must be able to be disconnected from the power grid, and the lines connected to the power line must be reliably grounded;
- The electrical equipment on site must be connected according to IEC 364 (DIN VDE 0100).
- Do not operate the machine with a damaged power cord. Immediately replace damaged power cords or plugs by professional technical service personnel;
- Dr. Coffee recommends that you do not use extension cables! If an extension cable must be used (minimum cross-section: 1.5 mm<sup>2</sup>), please observe the manufacturer's data (instruction manual) for the power cord and local regulations;
- Route the power cord so that people cannot trip over it. Do not let the power cord pass through sharp corners or hang in the air, and do not pinch cables. In addition, the cables must not be placed over high temperature objects and must be protected from oils and aggressive cleaning agents;
- Do not lift or pull on the device by the power cord. Do not pull the plug out of the socket by pulling on the power cord. Never touch the power cord or plug with wet hands! Never insert wet plugs into sockets!

### 5.1.4 Water conditions

#### **Poor quality raw materials and poor water quality can damage the machine. Be sure to observe the following points:**

- The water must be clean and contain no more than 100 mg of chlorine per liter;

- Do not add corrosive water to the coffee machine;
- Carbonate hardness must not exceed 5~6°dKH (German carbonate hardness) or 8.9~10.7° fKH (French carbonate hardness) and the total hardness value must always be higher than the carbonate hardness.
- Minimum carbonate hardness is 5°dKH or 8.9°fKH. pH must be between 6.5~7;
- The water supply must be connected in accordance with the current regulations and the regulations of the country in which it is used. If the machine is connected to a newly installed water line, the water line and inlet hose must be rinsed thoroughly to prevent stains from entering the machine.

## 5.2 First Run

**Power connection:** Take out the power cord and plug in the power.



**Filling coffee beans:** Open the coffee bean container lid, add coffee beans and install the lid.



Fill water: Open the lid, take out the water tank, and clean the inside of the water tank. Then add pure water to the water tank until it is 80% full, and finally put it back and close the lid.



Turn on the coffee machine: Press the power switch on the back of the machine as shown, and the coffee machine is connected to the power supply. Starts the machine and the screen displays the boot interface, it is ready to make drinks.



### 5.3 Machine On/Off

#### Method one

Step 1: In the standby state, press and hold the circular button on the top of the coffee machine for 3 seconds; then operate according to the prompts on the coffee machine interface, and enter the soft-off state after the shutdown is completed. (In soft-off state, press and hold the circular button for 3 seconds to restart the coffee machine.)



#### Method two

Step 1: Click the shortcut icon at the top of the screen to bring up the drop-down menu interface



Step2: Click on the "Power off" option in the drop-down menu.

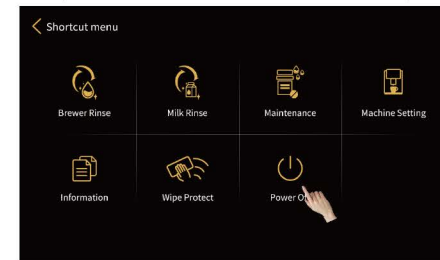

Step 3: Operate according to the prompts on the coffee machine interface, and enter the soft-off state after the shutdown is completed. (In soft-off state, press and hold the circular button for 3 seconds to restart the coffee machine.)

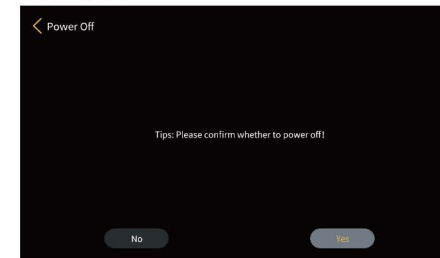

Step4: In soft-off state, press the power switch on the back of the coffee machine to completely cut off the power of the coffee machine. (Note: Do not directly cut off the power in the power-on state, so as not to cause damage to the machine.)



## 6 Beverage making

### 6.1 Coffee

► For example:make a cup of Espresso.

Step1:Click “Espresso” then coffee under processing.



Step2:During beverage making process.....,click “☕” on the screen, beverage parameter adjustment interface appears;



Step 3: Drag the adjustment lever on the right interface to temporarily adjust the amount; (only available in the adjustable mode) .



Step 4: During the process of making the drink..., click "Cancel" to stop the making immediately.



### 6.2 Milk Beverage

► For example:make a cup of Cappuccino.

Step1:Click” Cappuccino”then coffee under processing.



Step2:During beverage making process.....,click “☕” on the screen, beverage parameter adjustment interface appears;



Step 3: Drag the adjustment lever on the right interface to temporarily adjust the amount; (only available in the adjustable mode) .



Step 4: During the process of making the drink..., click "Cancel" to stop the making immediately.



### 6.3 Hot water

➤ For example:make a cup of hot water.

Step1:Click” hot water”then coffee under processing.



Step2:During beverage making process.....,click “☕” on the screen, beverage parameter adjustment interface appears;



Step 3: Drag the adjustment lever on the right interface to temporarily adjust the amount; (only available in the adjustable mode) .

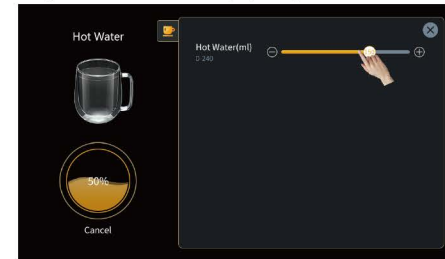

Step 4: During the process of making the drink..., click "Cancel" to stop the making immediately.

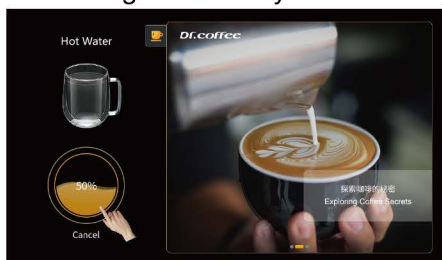

## 7 Cleaning and maintenance

### 7.1 Daily cleaning

➔ Daily cleaning operations needed to be performed daily.

#### 7.1.1 Brewer rinse

Step 1: Click the shortcut menu icon at the top of the screen to enter the shortcut menu interface.



Step 2: Click on the " Brewer Rinse " option on the screen to proceed to the next step

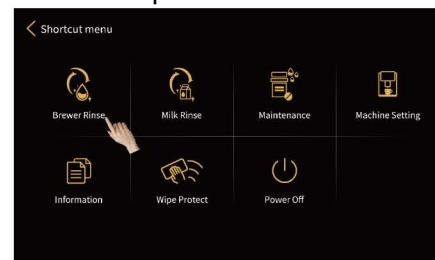

Step 3: Follow the prompts on the screen to rinse the brewing system.



✓ The Brewer Rinse complete and automatically returns to the main interface.

#### 7.1.2 Milk rinse

Step 1: Click the shortcut menu icon at the top of the screen to enter the shortcut menu interface.



Step 2: Click on the " Milk Rinse " option on the screen to proceed to the next step.

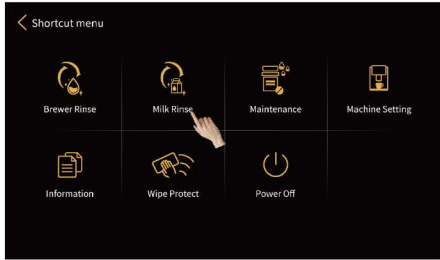

Step 3: Follow the prompts on the screen to rinse the milk system.



✓ The Milk Rinse complete and automatically returns to the main interface.

### 7. 1. 3 Milk frother disassembly and cleaning

Step 1: Remove the milk tube as shown.



Step 2: Pinch the clips on both sides of the milk frother with your fingers, and then pull down the milk frother firmly.

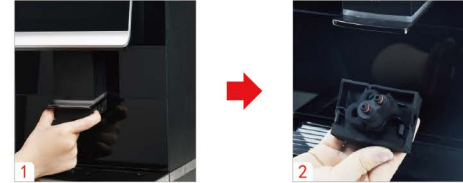

Step 3: Disassemble the coffee outlet, milk frother, connector and other components, and take them under the faucet for cleaning.



Step 4: Put the rinsed milk frother part back into the coffee machine as shown in the picture.



## 7.2 Regular maintenance

- ▶ Regular maintenance items that require the operator to follow the steps in the coffee machine cleaning instructions.

### 7.2.1 Brewer deep clean

Step 1: Click the shortcut menu icon at the top of the screen to enter the shortcut menu interface.



Step 2: Click "Maintenance" in the screen.

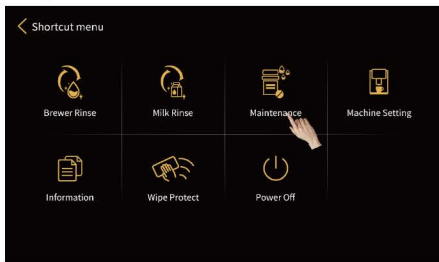

Step 3: Click "Brewer Deep Clean" on the screen, and follow the instructions on the screen step by step to perform deep cleaning of the brewing system.



### 7.2.2 Milk deep clean

Step 1: Click the shortcut menu icon at the top of the screen to enter the shortcut menu interface.



Step 2: Click "Maintenance" in the screen.

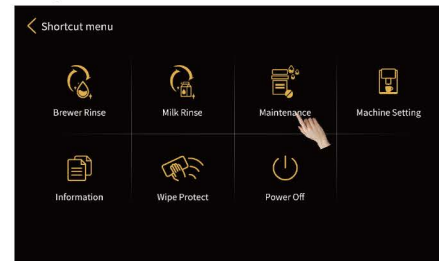

Step 3: Click "Milk Deep Clean" on the screen, and follow the instructions on the screen step by step to perform deep cleaning of the brewing system.





### 7.2.3 Descaling

Step 1: Click the shortcut menu icon at the top of the screen to enter the shortcut menu interface.



Step 2: Click "Maintenance" in the screen.

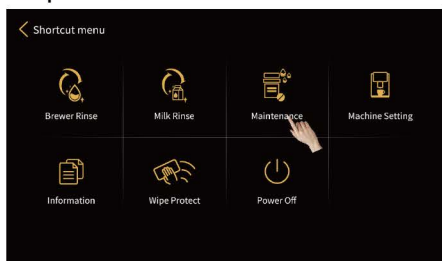

Step 3: Click "Decaling" on the screen, and follow the instructions on the screen step by step to perform deep cleaning of the brewing system.



### 7.2.4 Grinding adjustment

Step 1: Open the lid of the bean hopper, will see the thickness adjustment knob inside (the value of the dial: the larger the value, the coarser the beans).



Step 2: Click any drink on the screen to turn the grinder, and then turn the knob appropriately to adjust the thickness to a suitable level.



➤ Please be sure to adjust the knob when the grinder is turning, otherwise it may cause damage to the machine.

## 8 Precautions for daily use and maintenance

- Please do not add water to the coffee bean hopper;
- During the operation of the coffee machine, please do not open the door of the coffee machine forcibly, take out the grounds box, drip tray, water tank and other components;
- The external water tank can only be filled with pure water at room temperature, please do not add hot water or ice water;
- It is recommended to use coffee beans with medium roast or medium dark roast and not too oily. It is not recommended to use dark roasted or charcoal roasted and very oily coffee beans;
- When the beverage flows out, please do not put your hand at the outlet of the coffee machine to avoid burns;
- When cleaning the machine, please do not use a brush or cleaning agent, so as not to damage the appearance of the coffee machine, please wipe it with a soft cloth dampened with water;
- When filling beans or water, please do not exceed the MAX line. If there is no MAX line, fill it with 8 points.
- During the coffee making process, self-checking and resetting process, and automatic cleaning process, please do not cut off the power supply;
- According to the height of the coffee cup, adjust the height of the coffee outlet appropriately to avoid the splashing of beverages such as coffee and hot water;
- When shutting down, please follow the correct steps: please enter the shutdown interface of the screen, click "Pwer off", and follow the instructions on the screen. After the screen is off, press the power switch of the coffee machine to turn off the power. Do not directly press the power switch or pull out the power plug;
- Every day after the machine is turned off and stopped for use, please empty the coffee grounds and waste water in the machine and clean it;
- In order to ensure the quality of coffee, it is recommended to clean the water tank and replace the water in the water tank every day.
- This product cannot be immersed in water for cleaning.

## 9 Trouble shooting and Handling

Error	Solutions
Water Tank Is Empty	<ol style="list-style-type: none"> <li>1、 The water in the tank is already below the detection level; The water tank is not installed correctly and too far from the sensor;Water level sensor is broken;</li> <li>2、 Take out the tank and add water, make sure the water is not higher than the "Max" line marked on the tank;Check and reinstall the water tank; Replace a new sensor.</li> </ol>
Grounds Container Is Full Up	<ol style="list-style-type: none"> <li>1、 The grounds count in the grounds container reaches 15 pieces or is already full;</li> <li>2、 Pull out the drip tray, take out the grounds container, and empty the container.</li> </ol>
Bean Hopper Empty	<ol style="list-style-type: none"> <li>1、 Coffee bean hopper is empty;Beans sticks together;</li> <li>2、 Fill coffee beans to the bean box;Stir the beans in the bopper until they are loose.</li> </ol>
Drip Tray Is Not In Place	<ol style="list-style-type: none"> <li>1、 Not well fixed;Sensor broken ;Magnet loosing or broken;</li> <li>2、 Replace the drip tray;Replace new sensor;Replace new magnet.</li> </ol>
Drip tray is full up	<ol style="list-style-type: none"> <li>1、 The waste water in the tray is full;Sensor is dirty;</li> <li>2、 Pull out and empty the tray;Check and clean up the sensor.</li> </ol>
Coffee Thermo-Block Over-heated	<ol style="list-style-type: none"> <li>1、 Temperature is over 160 ℃;</li> <li>2、 Wait, as the tips in the Screen "The hot water thermo-block is cooling down, please wait ..."; While the thermo-block is cooling down, no beverage could be made..</li> </ol>
Steam Thermo- Block heating over time	<ol style="list-style-type: none"> <li>1、 Temperature is over 160 ℃;</li> <li>2、 While the steam thermo-block is cooling down, no beverage could be made.</li> </ol>
Diverted Valve checking	<ol style="list-style-type: none"> <li>1、 The valve is in the wrong position after multiple self-tests;</li> <li>2、 Tap "checking " to do self-checking; Switch off,5seconds later reboot the machine.</li> </ol>
Environment Temp. Is Too Low	<ol style="list-style-type: none"> <li>1、 The temperature of the environment is 0℃ or lower;</li> <li>2、 Please power on the machine when the temperature of environment is 10℃~40℃.</li> </ol>
Lack of Water	<ol style="list-style-type: none"> <li>1、 The inlet of tank r is blocked. The tank is unfixed; The strainer of Brewer is blocked;The Flowmeter damages;</li> <li>2、 Check the way of water supply and tap "Fill Water"; Check the tank outlet and reinstall it in place; clean the strainer, reinstall and push the tank to the end ; Clean the strainer by Brewer Deep Clean with tablets or by dissembling;Replace a new Flowmeter;Switch off and restart the machine;</li> </ol>

Error	Solutions
Pressure Overloaded	<ol style="list-style-type: none"> <li>1、 The pipe or strainer of Brewer is blocked;Coffee Grounds from Grinder are too fine; The amount Coffee Grounds from Grinder are over the max capacity of Brewer;Air is coming into the Pump while coffee making;</li> <li>2、 Tap "Rinse" to rinse Brewer;Adjust the gear position of the coffee machine to clockwise. The bigger number represents coarser. Clean the Inlet of tank.</li> </ol>
Grinder Calibration	<ol style="list-style-type: none"> <li>1、 After a certain cups of coffee made, it will alarm;It will alarm at the 2000th cup, 7000 th cup, 17000th cup, 27000th cup... and so on. ( every 10 thousand cups);</li> <li>2、 Follow the tips and enter service manual to do finish calibration; Follow the instruction of service manual.</li> </ol>
Brewer Check Up	<ol style="list-style-type: none"> <li>1、 The Brewer is not in a right position; The Brewer damaged; The drive motor of brewer damaged;</li> <li>2、 Tap "Check Up";Replace a new Brewer;Replace new drive motor.</li> </ol>
Brewer Unit Deep Clean Required	<ol style="list-style-type: none"> <li>1、 Reach the set value, it will alarm. Set in manual; The settled valve can be changed in the service manual;</li> <li>2、 Follow the tips and enter service manual to do deep clean; Follow the instructions of service manual.</li> </ol>
Milk System Deep Clean Required	<ol style="list-style-type: none"> <li>1、 Reach the set value, it will alarm. Set in manual; The settled valve can be changed in the service manual;</li> <li>2、 Follow the tips and enter service manual to do deep clean; Follow the instructions of service manual.</li> </ol>
Descaling Required	<ol style="list-style-type: none"> <li>1、 Reach the set value, it will alarm. Set in manual; The settled valve can be changed in the service manual;</li> <li>2、 Follow the tips and enter service manual to do deep clean; Follow the instructions of service manual.</li> </ol>
Water Leakage	<ol style="list-style-type: none"> <li>1、 Water leaking inside the machine;</li> <li>2、 Disassemble the appearance of the machine and check the specific leaking location; replace the accessories at the leaking location.</li> </ol>
No Coffee	<ol style="list-style-type: none"> <li>1、 The coffee grounds are too fine;The amount coffee grounds from grinder are over the max capacity of brewer;The pipe or strainer of Brewer is blocked;The Brewer damages;The Strainer of inlet valve is blocked;</li> <li>2、 Adjust the gear position of the coffee machine to clockwise. The bigger number represents coarser;Do grounds calibration;Do brewer deep rinse with tablets;Re-fix the Brewer, or replace a new Brewer; Clean Strainer or replace a new one;</li> </ol>
Brewer System Error	<ol style="list-style-type: none"> <li>1、 Tap three times "brewer self-checking", prompts brewer system error; The brewer is blocked is stuck;The motor doesn't work; The brewer damages; Control Board damages;</li> <li>2、 Switch off the machine and restart;Disassemble the brewer , check and clean;Replace a new motor; Replace a new Brewer;Replace a new Control Board;</li> </ol>

Error	Solutions
HMI Communication Error	<ol style="list-style-type: none"> <li>1、 Main board and display board connection loose or damaged; Control software doesn't match with the HMI software;HMI PCB damages; Main Board damages;</li> <li>2、 Check the plugs on HMI PCB and reconnect;Upgrade Control software and HMI Software;Replace a new HMI PCB;Replace a new Main Board.</li> </ol>
Coffee Thermo-block NTC Error	<ol style="list-style-type: none"> <li>1、 Electronic fault between sensor and master;The temperature of the thermo-block exceeds 180 °C;</li> <li>2、 Replace the connectors of thermo-block;Replace the NTC sensor; Switch off and restart after 30 minutes;Replace thermo-block group.</li> </ol>
Steam Thermo-block NTC Error	<ol style="list-style-type: none"> <li>1、 Electronic fault between sensor and master;The temperature of the thermo-block exceeds 180 °C;</li> <li>2、 Replace the connectors of thermo-block;Replace the NTC sensor; Switch off and restart after 30 minutes; Replace thermos-block group.</li> </ol>
Coffee Thermo-block Heating Overtime	<ol style="list-style-type: none"> <li>1、 The temperature of the thermo-block exceeds settled value and fuse burn outsensor damage; Thermo-block damage;</li> <li>2、 Replace the fuse of thermo-block; Replace the NTC sensor; Replace thermo-block group.</li> </ol>
Steam Thermo-block Heating Overtime	<ol style="list-style-type: none"> <li>1、 The temperature of the thermo-block exceeds settled value and fuse burn outsensor damage; Thermo-block damage;</li> <li>2、 Replace the fuse of thermo-block; Replace the NTC sensor; Replace thermo-block group.</li> </ol>
Diverted Valve Error	<ol style="list-style-type: none"> <li>1、 The valve is still in the wrong position after multiple self-tests; Valve damage;</li> <li>2、 Switch off , 5seconds later reboot the machine change valve.</li> </ol>
Fail to switching on	<ol style="list-style-type: none"> <li>1、 No power ;Voltage isn't high enough; Not Switched on; Power PCB damages; The fuse of Main Power is blown;</li> <li>2、 Check if the machine is connected with power; Connect the machine with acceptable power;Check if the machine is switched on; Replace a new Power PCB;Replace a new fuse.</li> </ol>
Crash	<ol style="list-style-type: none"> <li>1、 System stops unexpectedly;</li> <li>2、 Turn off the machine, wait for about 5 seconds, then turn it on again; upgrade the system program of the coffee machine.</li> </ol>
No Milk	<ol style="list-style-type: none"> <li>1、 The milk box is empty; The pipe or outlet of steam is blocked; The pipe of steam is broken; The number of Air Intake is set too high. The Milk Frother is blocked;</li> <li>2、 Refill milk to the milk box;Do milk deep Rinse;Dissemble the cover of machine, check the pipe of steam;Set the number of Air Intake lower; Dissemble and clean the milk frother ;replace a new milk frother.</li> </ol>
No Milk Foam, Warm Milk Only	<ol style="list-style-type: none"> <li>1、 The inlet of Air Intake Valve is blocked;The pipe of Air Intake Valve is blocked;The Air Intake Valve damages;</li> <li>2、 Check the inlet and the pipe of Air Intake Replace a new Air Intake Valve.</li> </ol>